

marelli

# WORKSHAKER

STRIPES  
L-SOFA/H-SOFA  
PIVOT

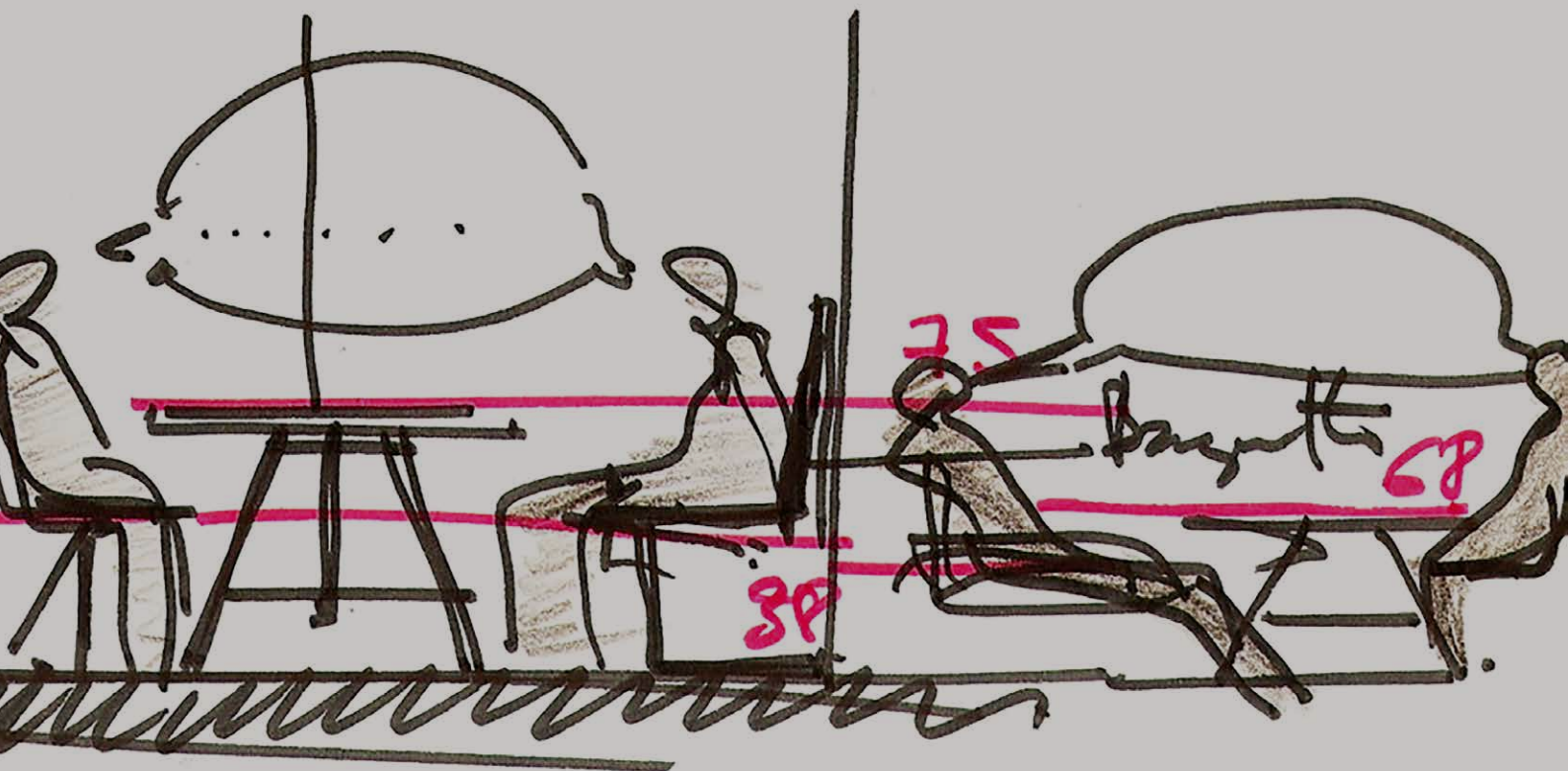



**Jérôme Gauthier**  
Designer of the  
WORKSHAKER collection

# WORKSHAKER

STRIPES  
L-SOFA/H-SOFA  
PIVOT

With WORKSHAKER, based on the Stripes and L-Sofa models, Jérôme Gauthier proposes professional environments suited to workers' highly-evolved tools and methods. Characterized by phonic and visual insulation conducive to reflection, collective meeting zones and individual work zones cohabit in the same optimized space. The alternating horizontal supports (seat, table and tray) and the vertical surfaces (file partitioning) encourage a variety of postures in a multitude of situations.

This diversity of spatial positions – face to face, side by side, back to back – and the quality of exchanges it allows, is enriched by the rotating seat and the height adjustable table Pivot, linked to the Stripes Back Tray and L-Sofa Light. Integrated solutions for electrical and computer connections facilitate the use of tables and trays. Independent electrical and lighting additions augment connection possibilities and users' mobility. Marelli introduces a mix of versatile and easily expandable organizational solutions to furnish easy to access and use work spaces.

# marelli

## marelli



Marelli stand at the 2014  
 ORGATEC Exhibition.  
 First presentation  
 of the WORKSHAKER Collection.

**STRIPES** "Y" composition made of 2 elements with left armrest 9SS618 cm 225/185x73x96h with corner 60°, 2 elements with right armrest 9SS619 cm 225/185x73x96h with right armrest with corner 60° in fabric cat. B art. Atlantic col. 64116, 2 shelves 9SS430 cm 229x36x77h in natural oak HPL and small cushions 9RL112 cm 80x40 in fabric cat. B art. Atlantic col. 62048. Belux lamps 9SS805, Schulte Evoline socket 9SS802, mobile shelf 9SS806 and mobile socket 9SS801.

**PIVOT** swivel armchairs 9PIV101 cm 55,5x54x80h with natural oak structure and seat and back in fabric cat. B art. Atlantic in the colours 64116 red, 62048 green and 61163 grey; **PIVOT** tables 7PIV101 ø cm 60x43/61H in natural oak.

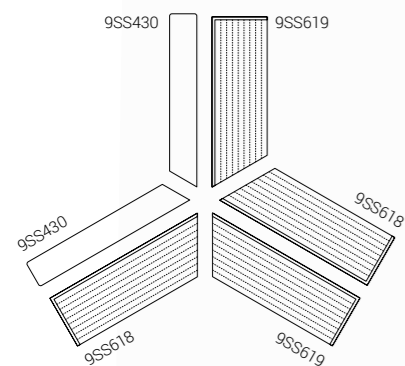
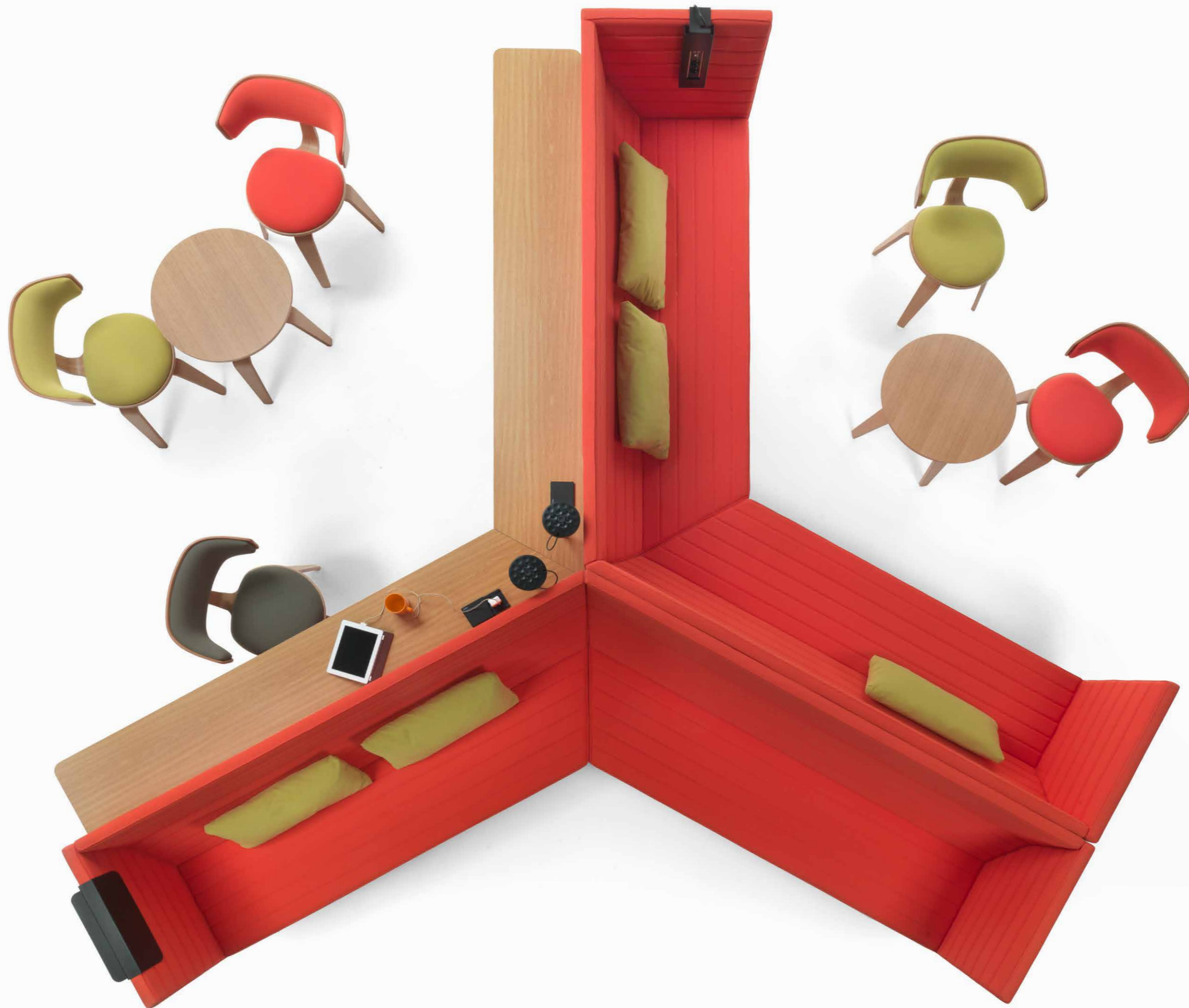

**STRIPES** "Y" composition made of 2 elements with left armrest 9SS618 cm 225/185x73x96h with corner 60°, 2 elements with right armrest 9SS619 cm 225/185x73x96h with right armrest with corner 60° in fabric cat. B art. Atlantic col. 64116, 2 shelves 9SS430 cm 229x36x77h in natural oak HPL and small cushions 9RL112 cm 80x40 in fabric cat. B art. Atlantic col. 62048. RAL 9017 black painted metal bases. Belux lamps 9SS805, Schulte Evoline socket 9SS802, mobile shelf 9SS806 and mobile socket 9SS801. **PIVOT** swivel armchairs 9PIV101 cm 55,5x54x80h with natural oak structure and seat and back in fabric cat. B art. Atlantic in the colours 64116 red and 62048 green; **PIVOT** tables 7PIV101 ø cm 60x43/61H in natural oak.

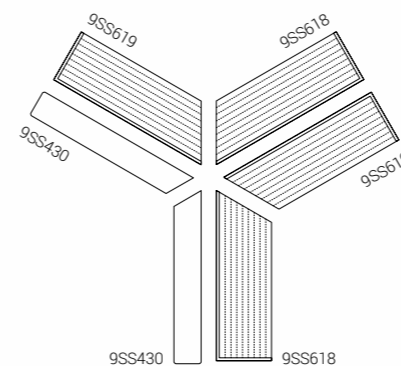

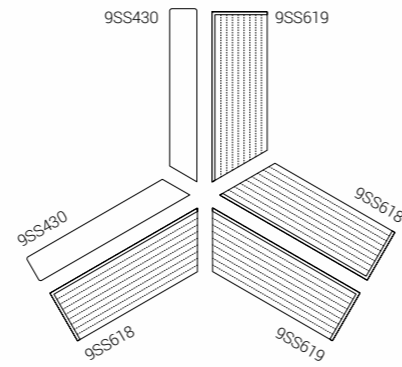

**STRIPES** "Y" composition made of 2 elements with left armrest 9SS618 cm 225/185x73x96h with corner 60°, 2 elements with right armrest 9SS619 cm 225/185x73x96h with right armrest with corner 60° in fabric cat. B art. Atlantic col. 64116, 2 shelves 9SS430 cm 229x36x77h in natural oak HPL and small cushions 9RL112 cm 80x40 in fabric cat. B art. Atlantic col. 62048. Belux lamps 9SS805, Schulte Evoline socket 9SS802, mobile shelf 9SS806 and mobile socket 9SS801.

**PIVOT** swivel armchairs 9PIV101 cm 55,5x54x80h with natural oak structure and seat and back in fabric cat. B art. Atlantic in the colours 64116 red and 62048 green; **PIVOT** table 7PIV101 ø cm 60x43/61H in natural oak.



Detail of **STRIPES** "Y" composition in fabric cat. B art. Atlantic col. 64116 with shelves in natural oak HPL, Belux lamps 9SS805, Schulte Evoline sockets 9SS802, mobile socket 9SS801 and **PIVOT** swivel armchair 9PIV101 with back and seat in fabric cat. B art. Atlantic col. 64116 and frame in natural oak.





*Detail of mobile socket 9SS801  
on **STRIPES** "Y" composition  
in fabric cat. B art. Atlantic col. 64116.*





**STRIPES** composition made of 2 sofas 9SS208 cm 185x73x133h in fabric cat. B art. Atlantic col. 61163 with cushions 9RL112 cm 80x40 in fabric cat. B art. Atlantic col. 66086 with shelf 9SS423 cm 193x36x115h and table 9SS441 cm 82x133x133h in natural oak HPL. Bachmann Power Frame electric module 9SS803, mobile lamp 9SS804, Belux lamp 9SS805 and Schulte Evoline socket 9SS802.

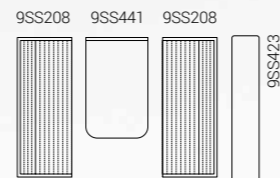

**STRIPES** composition made of 2 sofas 9SS208 cm 185x73x133h in fabric cat. B art. Atlantic col. 61078 with cushions 9RL112 cm 80x40 in fabric cat. B art. Atlantic col. 66086 with shelf 9SS422 cm 193x36x77h and table 9SS441 cm 82x133x133h in natural oak HPL. Bachmann Power Frame electric module 9SS803, mobile lamp 9SS804, Belux lamp 9SS805 and Schulte Evoline socket 9SS802. **PIVOT** swivel armchair 9PIV101 cm 55,5x54x80h with natural oak frame and back and seat in fabric cat. B art. Atlantic col. 66086.

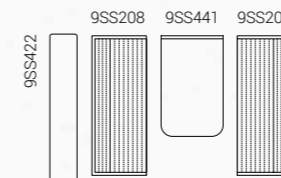

**STRIPES** composition made of 2 sofas 9SS208 cm 185x73x133h in fabric cat. B art. Atlantic col. 61078 with cushions 9RL112 cm 80x40 in fabric cat. B art. Atlantic col. 66086 with shelf 9SS422 cm 193x36x77h and table 9SS441 cm 82x133x133h in natural oak HPL. Bachmann Power Frame electric module 9SS803, mobile lamp 9SS804, Belux lamp 9SS805 and Schulte Evoline socket 9SS802. **PIVOT** swivel armchair 9PIV101 cm 55,5x54x80h with natural oak frame and back and seat in fabric cat. B art. Atlantic col. 66086.

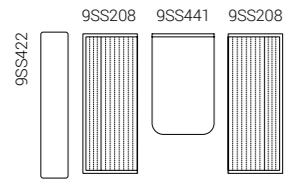

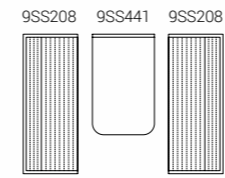

Detail of **STRIPES** composition made of 2 sofas 9SS208 cm 185x73x133h in fabric cat. B art. Atlantic col. 61078 with cushions 9RL112 cm 80x40 in fabric cat. B art. Atlantic col. 66086 with table 9SS441 cm 82x133x133h in natural oak HPL. Bachmann Power Frame electric module 9SS803 and mobile lamp 9SS804.



**STRIPES** sofa 9SS208 cm 185x73x133h in fabric cat. B art. Atlantic col. 61163 with back shelf 9SS423 cm 193x36x115h in natural oak HPL, RAL 9017 black painted metal base, Belux lamp 9SS805 and mobile socket 9SS801. **STRIPES** composition made of 2 sofas 9SS208 cm 185x73x133h in fabric cat. B art. Atlantic col. 61078 with cushions 9RL112 cm 80x40 in fabric cat. B art. Atlantic col. 64116 with shelf 9SS422 cm 193x36x77h and table 9SS441 cm 82x133x133h in natural oak HPL. Belux lamp 9SS805 and Schulte Evoline socket 9SS802.

**PIVOT** swivel armchair 9PIV101 cm 55,5x54x80h with natural oak frame and back and seat in fabric cat. B art. Atlantic col. 64116.

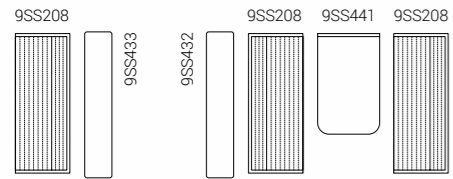

**STRIPES** composition made of 1 sofa 9SS222 cm 185x73x86h with left armrest and 1 sofa 9SS221 cm 185x73x86h with right armrest in fabric cat. B art. Atlantic col. 61078 with shelves 9SS434 cm 189x36x77h with black painted metal base, mobile shelf 9SS806, Belux lamp 9SS805 and mobile socket 9SS801. **PIVOT** swivel armchairs 9PIV101 cm 55,5x54x80h with natural oak frame and seat and back in fabric cat. B art. Atlantic col. 64116 red and 60063 beige and **PIVOT** table 7PIV101 ø cm 60x43/61h in natural oak.

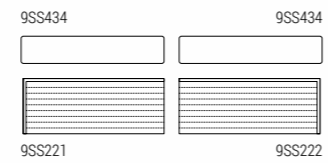

**STRIPES** composition made of 1 sofa 9SS222 cm 185x73x86h with left armrest and 1 sofa 9SS221 cm 185x73x86h with right armrest in fabric cat. B art. Atlantic col. 61078 with shelves 9SS434 cm 189x36x77h with black painted metal base, mobile shelf 9SS806, Belux lamp 9SS805 and Schulte Evoline socket 9SS802. **PIVOT** swivel armchairs 9PIV101 cm 55,5x54x80h with natural oak frame and seat and back in fabric cat. B art. Atlantic col. 64116 red, 60063 beige and 61163 grey and **PIVOT** tables 7PIV101 ø cm 60x43/61 and 7PIV102 ø 78x43/74h in natural oak.



**STRIPES** composition made of 2 corner elements 9SS401 cm 73x73x133h in fabric cat. B art. Atlantic col. 60063 beige and table 9SS444 cm 82x55x133h in natural oak HPL.

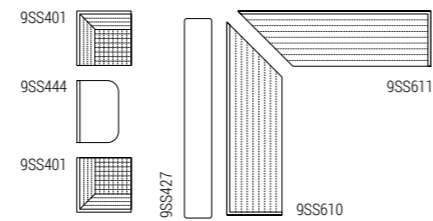

**STRIPES** composition made of 1 sofa with left armrest 9SS610 cm 255/185x73x133h with corner 45° and 1 sofa with right armrest 9SS611 cm 255/185x73x133h with corner 45° in fabric cat. B art. Atlantic col. 60063 beige, black painted metal bases, shelf 9SS427 cm 263x36x115h in natural oak HPL, Belux lamp 9SS502 and cushions 9RL112 cm 80x40 in fabric cat. B art. Atlantic col. 61163. **PIVOT** swivel armchairs 9PIV101 cm 55,5x54x80h with natural oak frame and seat and back in fabric cat. B art. Atlantic col. 60063 beige and 61163 grey and **PIVOT** tables 7PIV101 ø cm 60x43/61 and 7PIV102 ø 78x43/74h in natural oak.



**H-SOFA** composition cm 308x462 in fabric cat. B art. Atlantic col. 60063 beige with wooden panels and tables in natural oak and black painted metal base. Schulte Evoline sockets 9SS802 and Belux lamps 9SS805. **PIVOT** swivel armchairs 9PIV101 cm 55,5x54x80h with natural oak frame and seat and back in fabric cat. B art. Atlantic col. 60063 beige and 61163 grey and **PIVOT** table 7PIV101 ø cm 60x43/61 in natural oak.

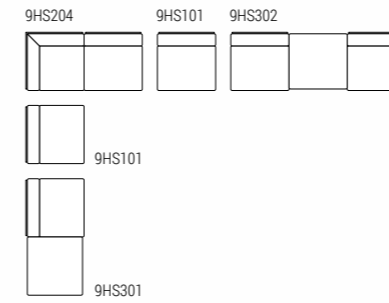



**H-SOFA** composition cm 308x462 in fabric cat. B art. Atlantic col. 60063 beige with wooden panels and tables in natural oak and black painted metal base. Schulte Evoline sockets 9SS802 and Belux lamps 9SS805.

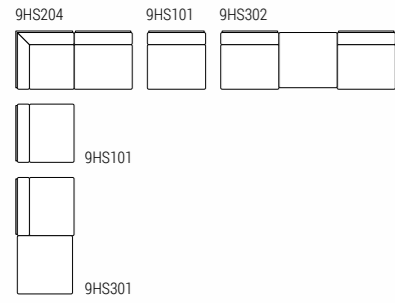



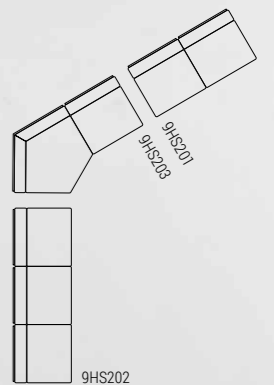

**H-SOFA** composition cm 308x308 in fabric cat. B art. Atlantic col. 61163 with black painted metal base and natural oak wooden panels. **PIVOT** swivel armchairs 9PIV101 cm 55,5x54x80h with natural oak frame and seat and back in fabric cat. B art. Atlantic col. 62048 and **PIVOT** tables 7PIV101 ø cm 60x43/61 and 7PIV102 ø 78x43/74h in natural oak.

**H-SOFA** composition cm 308x308 in fabric cat. B art. Atlantic col. 61163 with black painted metal base and natural oak wooden panels. **PIVOT** swivel armchairs 9PIV101 cm 55,5x54x80h with natural oak frame and seat and back in fabric cat. B art. Atlantic col. 62048 and **PIVOT** tables 7PIV101 ø cm 60x43/61 and 7PIV102 ø 78x43/74h in natural oak.

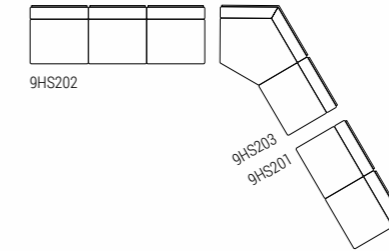

**L-SOFA** sofas 9LF207 cm 260x78x70h in fabric cat. B art. Atlantic col. 61078 with natural oak wooden panels, black painted metal base and cushions 9RL112 cm 80x40 in fabric cat. B art. Atlantic col. 61163. **PIVOT** swivel armchairs 9PIV101 cm 55,5x54x80h with natural oak frame and seat and back in fabric cat. B art. Atlantic col. 60063 beige and 61163 grey and **PIVOT** tables 7PIV101 ø cm 60x43/61 and 7PIV102 ø 78x43/74h in natural oak.



**L-SOFA** sofas 9LF207 cm 260x78x70h in fabric cat. B art. Atlantic col. 61078 with natural oak wooden panels and black painted metal base.



# Stripes

Design Jérôme Gauthier 2009

Divani  
Sofas

SEAT HEIGHT 37



**9SS112**  
L80 P73 H96



**9SS101**  
L145 P73 H37

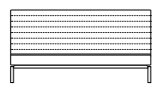

**9SS209**  
L185 P73 H96



**9SS505**  
L73 P73 H96  
Corner element



**9SS113**  
L80 P73 H96  
Swivel armchair



**9SS201**  
L145 P73 H96

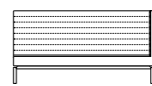

**9SS210**  
L185 P73 H96



**9SS114**  
L90 P73 H96

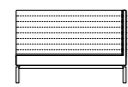

**9SS202**  
L145 P73 H96

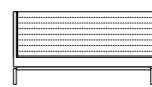

**9SS211**  
L185 P73 H96



**9SS203**  
L145 P73 H96

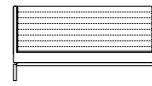

**9SS212**  
L185 P73 H96



**9SS204**  
L145 P73 H96

Con angolo a 45°  
With corner 45°

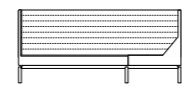

**9SS604**  
L215/145 P73 H96



**9SS616**  
L185/145 P73 H96

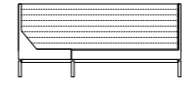
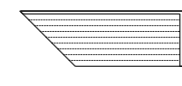

**9SS605**  
L215/145 P73 H96

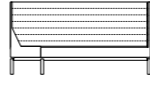

**9SS617**  
L185/145 P73 H96

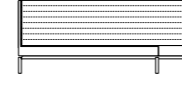
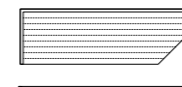

**9SS606**  
L255/185 P73 H96

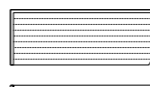

**9SS618**  
L225/185 P73 H96

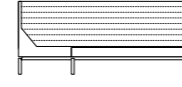

**9SS607**  
L255/185 P73 H96

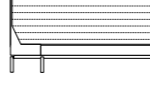
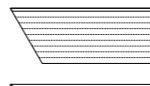

**9SS619**  
L225/185 P73 H96

4  $\frac{73}{49}$



Divani  
Sofas

SEAT HEIGHT 42,5



**9SS213**  
L80 P73 H86

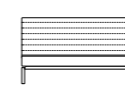

**9SS216**  
L145 P73 H86



**9SS220**  
L185 P73 H86



**9SS224**  
L73 P73 H86  
Corner element



**9SS214**  
L80 P73 H86  
Swivel armchair

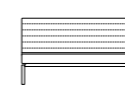

**9SS217**  
L145 P73 H86

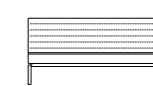

**9SS221**  
L185 P73 H86



**9SS215**  
L90 P73 H86

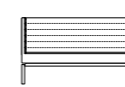

**9SS218**  
L145 P73 H86



**9SS222**  
L185 P73 H86

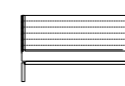

**9SS219**  
L145 P73 H86

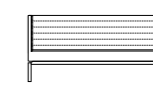

**9SS223**  
L185 P73 H86

Con angolo a 45°  
With corner 45°

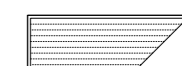

**9SS600**  
L215/145 P73 H86

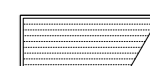

**9SS612**  
L185/145 P73 H86

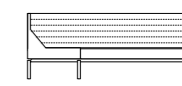

**9SS601**  
L215/145 P73 H86

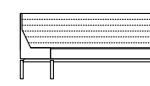
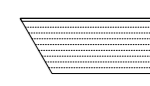

**9SS613**  
L185/145 P73 H86



**9SS602**  
L255/185 P73 H86



**9SS614**  
L225/185 P73 H86

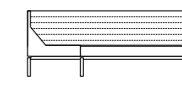
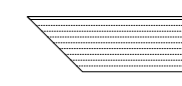

**9SS603**  
L255/185 P73 H86

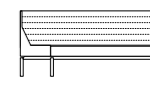
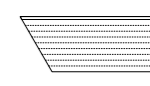

**9SS615**  
L255/185 P73 H86

4  $\frac{73}{49}$

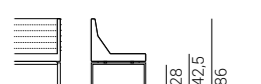

# Stripes

Design **Jérôme Gauthier** 2009

Divani  
Sofas

SEAT HEIGHT 42,5

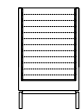

**9SS107**  
L80 P73 H133

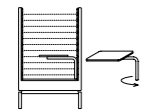

**9SS109**  
L80 P73 H133  
*Armchair with mobile writing shelf*



**9SS103**  
L185 P73 H42,5

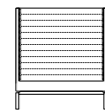

**9SS304**  
L120 P73 H133

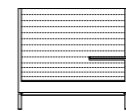

**9SS402**  
L145 P73 H133  
*Sofa with fixed writing shelf*



**9SS401**  
L73 P73 H133  
*Corner element*



**9SS108**  
L80 P73 H133  
*Swivel armchair*

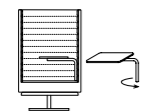

**9SS111**  
L80 P73 H133  
*Swivel armchair with mobile writing shelf*

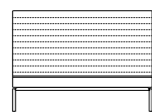

**9SS205**  
L185 P73 H133

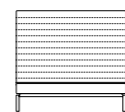

**9SS301**  
L145 P73 H133

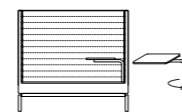

**9SS503**  
L145 P73 H133  
*Sofa with mobile writing shelf*



**9SS105**  
L90 P73 H133

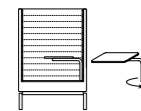

**9SS110**  
L90 P73 H133  
*Armchair with mobile writing shelf*

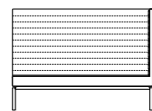

**9SS206**  
L185 P73 H133

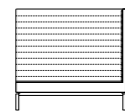

**9SS302**  
L145 P73 H133

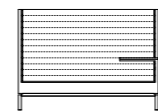

**9SS502**  
L185 P73 H133  
*Sofa with fixed writing shelf*

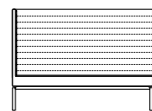

**9SS207**  
L185 P73 H133

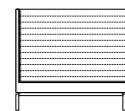

**9SS303**  
L145 P73 H133

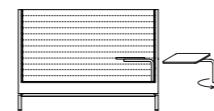

**9SS504**  
L185 P73 H133  
*Sofa with mobile writing shelf*

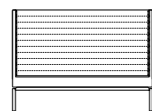

**9SS208**  
L185 P73 H133

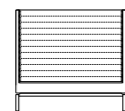

**9SS305**  
L145 P73 H133

Con angolo a 45°  
*With corner 45°*

Con angolo a 60°  
per composizione a "Y"  
*With corner 60°  
for composition "Y"*

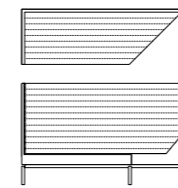

**9SS608**  
L215/145 P73 H133

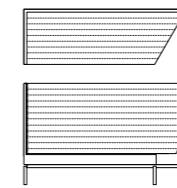

**9SS620**  
L215/145 P73 H133

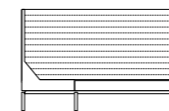
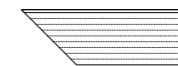

**9SS609**  
L215/145 P73 H133

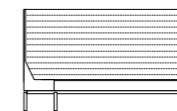

**9SS621**  
L215/145 P73 H133

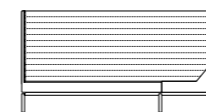
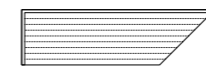

**9SS610**  
L255/185 P73 H133

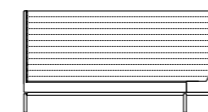

**9SS622**  
L255/185 P73 H133

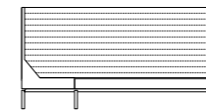

**9SS611**  
L255/185 P73 H133

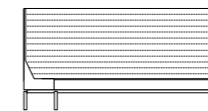

**9SS623**  
L255/185 P73 H133

Accessori  
*Accessories*

Cuscinetto in piuma  
senza fascia  
*Feather cushion  
without band*



**9RL112**  
L80 H40

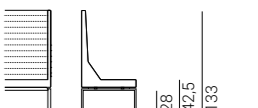



# Stripes

Design **Jérôme Gauthier** 2009

Tavoli  
Tables

**9SS102**  
L60 P30 H62  
Server with metal top

**9SS106**  
L60 P30 H62  
Server with wooden top

**9SS104**  
L73 P73 H37  
Small table with transparent glass top

**9SS403/9SS407/9SS411**  
L82 P133 H133  
Table

**9SS404/9SS408/9SS412**  
L82 P55 H133  
Table

**9SS406/9SS410/9SS413**  
L73 P41 H133  
Table

**9SS405/9SS409/9SS414**  
L185 P41 H133  
Table

**9SS440/9SS441/9SS442**  
L82 P133 H133  
Table

**9SS443/9SS444/9SS445**  
L82 P55 H133  
Table

Mensole per divani  
Shelves for sofas

**9SS420**  
L153 P36 H77

**9SS421**  
L153 P36 H115

**9SS422**  
L193 P36 H77

**9SS423**  
L193 P36 H115

**9SS432**  
L149 P36 H77

**9SS433**  
L149 P36 H115

**9SS434**  
L189 P36 H77

**9SS435**  
L189 P36 H115

Mensole per divani con angolo a 45°  
Shelves for sofas with corner 45°

**9SS424**  
L223 P36 H77

**9SS425**  
L223 P36 H115

**9SS426**  
L263 P36 H77

**9SS427**  
L263 P36 H115

Mensole per divani con angolo a 60° per composizione a "Y"  
Shelves for sofas with corner 60° for composition "Y"

**9SS428**  
L189 P36 H77

**9SS429**  
L189 P36 H115

**9SS430**  
L229 P36 H77

**9SS431**  
L229 P36 H115

Opzionali  
Optionals

**9SS801**  
L11 P5 H31  
Mobile socket

**9SS802**  
L10 P10  
Schulte Evoline socket

**9SS803**  
L25,5 P9  
Bachmann Power Frame electric module

**9SS804**  
L27 P16 H7,5 (totale H24)  
Mobile lamp

**9SS805**  
ø14 H32  
Belux lamp

**9SS806**  
L42 P20 H24  
Mobile shelf

Feet code	Polished Chromed Metal OPM1	Matt Brushed Metal OPM2	Black Painted Metal OPM6	White Painted Metal OPM7	Metal Painted in RAL Classic Colors OPM8	RAL 9006 Aluminium Painted Metal
	●	●	●	●	●	●

# Stripes

Design Jérôme Gauthier 2009

Fusto in legno massello e legno multistrato rivestito in poliuretano espanso e dacron con cinghie elastiche intrecciate. Seduta e schienale imbottitura in poliuretano espanso a quote differenziate di densità di 40 kg/m³ e 70 kg/m³, rivestita con dacron. Rivestimento fisso. Il prodotto è caratterizzato da una trapuntatura, che può essere verticale o orizzontale. Il basamento è in metallo verniciato color alluminio RAL 9006, bianco, nero, o a richiesta in tutti gli altri colori RAL standard, cromato lucido o satinato.

*Frame made of solid wood and multi-ply wood with interwoven elastic straps. Seat and back upholstered with polyurethane foam with density 40 kg/m³ and 70 kg/m³, covered with dacron. Fixed covers. The model is characterized by the quilting, which can be vertical or horizontal. Metal base painted in colour RAL 9006 aluminium, white, black or, on request, in all the other RAL standard colours, polished chrome or matt brushed.*

*Das Gestell besteht aus Massiv- und Schichtholz, mit geflochtenen Gummigurten. Sitz und Rückenlehne gepolstert mit Polyurethan-Schaumstoff 40 kg/m³ and 70 kg/m³, mit Dacron bezogen. Stripes ist immer festbezogen. Das Modell zeichnet sich aus durch die Absteppung, die senkrecht oder waagrecht sein kann. Metallsockelgestell lackiert in der Farbe aluminium RAL 9006, schwarz, weiss, oder auf Wunsch in allen anderen RAL Standard-Farben, glänzend verchromt oder matt satiniert.*

*Carcasse en bois massif et multiplis muni de bandes élastiques entrecroisées. Assise et dossier finis de mousse polyuréthane de densité de 40 kg/m³ et 70 kg/m³, couverte de dacron. Revêtement toujours fixe. Le modèle est caractérisé par le brochage, qui peut être vertical ou horizontal. Le piètement est en métal laqué couleur aluminium RAL 9006, blanc, noir, ou, sur demande, dans toutes les autres couleurs RAL standard, chromé brillant ou chromé satiné.*

*Frame in massief hout en multiplex, voorzien van door elkaar geweven elastische singels. Zit en rug zijn bekleed met koudschuim met een densiteit van 40 kg/m³ en 70 kg/m³, afgewerkt met dacron. De bekleding is altijd vast. Typisch voor het model is de doorstikking, die verticaal of horizontaal uitgevoerd kan worden. Het onderstel is uitgevoerd in gelakt metaal kleur aluminium RAL 9006, wit, zwart, of op aanvraag in alle andere standaard-RAL-kleuren, of nog chroom of matchroom.*

*Несущая структура: массив дерева и многослойные панели с покрытием из пенополиуретана и дакрона. Пружинение сиденья: плетеные эластичные ремни. Сиденье и спинка: набивка из пенополиуретана с дифференцированными участками, с плотностью 40 кг/куб.м и 70 кг/куб. м, с покрытием из термосвязанных волокон. Покрытие: Не снимается. Изделие имеет характерную стежку по горизонтали или по вертикали. Основание из окрашенного металла.*

# L-Sofa

Design Jérôme Gauthier 2013

## Divani Sofas



**9LF101**  
L112 P78 H70

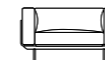

**9LF102**  
L128 P78 H70

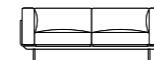

**9LF201**  
L188 P78 H70



**9LF202**  
L220 P78 H70



**9LF207**  
L260 P78 H70



**9LF203**  
L170 P78 H70



**9LF204**  
L202 P78 H70



**9LF103**  
L110 P78 H70



**9LF107**  
L94 P78 H70

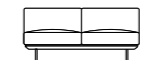

**9LF205**  
L152 P78 H70



**9LF206**  
L184 P78 H70



**9LF104**  
L92 P78 H70



**9LF108**  
L76 P78 H70

## Elementi componibili Modular elements

## Pouf e accessori Pouf and accessories



**9LF105**  
L92 P92 H42



**9LF106**  
L108 P108 H42

Cuscinetto in piuma senza fascia  
Feather cushion without band



**9RL112**  
L80 H40

Top in legno  
Wood Top



**7LF101**  
L92 P92 H23



**7LF102**  
L108 P108 H23

## Base in metallo Metal Base

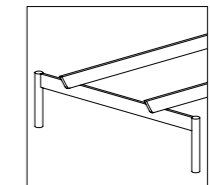

**Versione A**  
Basamento in metallo verniciato  
Version A  
Painted metal base

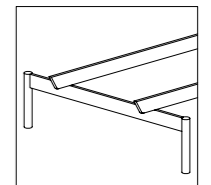

**Versione B**  
OPM1, OPM2, OPM3  
Version B  
OPM1, OPM2, OPM3

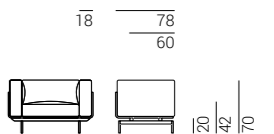

Code	Cherry Stained Oak OPR1	Wengé Stained Oak OPR2	Walnut Stained Oak OPR3	Natural Oak OPR4	Black Stained Oak OPR5	Cherry Milano Stained Oak OPR6	Tobacco Stained Oak OPR8	Grey taupe Stained Oak OPR9	Whitened Oak OPR10	Charcoal Stained Oak OPR11	Mahogany Stained Oak OPR12
Wooden Panels	●	●	●	●	●	●	●	●	●	●	●
Wooden Panels	●	●	●	●	●	●	●	●	●	●	●
Code	OPM1	OPM2	OPM3	OPM6	OPM7	OPM9					
Metal Base A	●	●	●	●	●	●	●	●	●	●	●
Metal Base B	●	●	●	●	●	●	●	●	●	●	●

# L-Sofa

Design **Jérôme Gauthier** 2013

Composizione divano  
Sofa conception



# L-Sofa

Design **Jérôme Gauthier** 2013

Struttura portante costituita da due tubolari di metallo cm 4 x 3. Piede in metallo diametro cm 2,5. Pannelli in multistrato impiallacciato rovere, spessore 2,1 cm. Cuscini in poliuretano espanso a quote differenziate, rivestito in dacron 100 gr: sedile T.40RC (kPa5), schienale PF30 (kPa4,3), PF30M (kPa 3,5), T.30HR (kPa 1,5); braccioli PF30 (kPa 4,3), T.30HR (kPa 1,5). Il rivestimento è sempre fisso.

Frame made of two metal tubes cm 4 x 3. Metal leg diameter cm 2.5. Multiply oak veneer panels, 2.1 cm thick. Cushions made of polyurethane foam in different densities, covered with dacron 100 gr: seat T.40RC (kPa5); back PF30 (kPa 4,3), PF30M (kPa 3,5), T.30HR (kPa 1,5); armrests PF30 (kPa 4,3), T.30HR (kPa 1,5). Covers are always fixed.

Gestellkonstruktion mit 2 Querträgern 4-Kantrohr 4 x 3 cm, Metallfüsse mit Durchmesser 2,5 cm. Rücken- und Armlehnelemente aus Schichtholz Eiche furniert, Dicke 2,1 cm. Kissen aus Polyurethanschäumstoff in unterschiedlichen Dichten, mit Dacron 100 gr ummantelt: Sitzkissen T.40RC (kPa5); Rückenissen PF30 (kPa4,3), PF30M (kPa 3,5), T.30HR (kPa 1,5); Armlehnkissen PF30 (kPa 4,3), T.30HR (kPa 1,5). L-Sofa ist immer fix bezogen.

Structure portante constituée de deux tubes en métal de 4 x 3 cm. Pied en métal diamètre 2,5 cm. Panneaux en multiplis plaqués chêne, épaisseur 2,1 cm. Coussins en mousse polyuréthane de différentes densités, revêtue de dacron 100 gr: assise T.40RC (kPa5); dossier PF30 (kPa4,3), PF30M (kPa 3,5), T.30HR (kPa 1,5); accoudoirs PF30 (kPa 4,3), T.30HR (kPa 1,5). Le revêtement est toujours fixe.

De dragende structuur bestaat uit twee metalen buizen van 4 x 3 cm. Metalen poot diameter 2,5 cm. Multiplexpanelen eik gefineerd, dikte 2,1 cm. Kussens in koudschuim van verschillende densiteit, afgewerkt met dacron 100 gr: zit T.40RC (kPa5); rug PF30 (kPa4,3), PF30M (kPa 3,5), T.30HR (kPa 1,5); armleuningen PF30 (kPa 4,3), T.30HR (kPa 1,5). De bekleding is altijd vast.

Несущий каркас образован двумя металлическими планками, размер в сечении 4 x 3см. Металлические ножки диаметром 2,5см. Панели из многослойной фанеры, отделанной шпоном дуба, толщина панели 2,1см. Наполнение подушек: вспененный полиуретан с участками различной плотности в чехле из дакрона весом 100гр. Подушка сиденья T.40RC (kPa5); подушка спинки schienale PF30 (kPa4,3), PF30M (kPa 3,5), T.30HR (kPa 1,5); подлокотники PF30 (kPa 4,3), T.30HR (kPa 1,5). Чехлы несъемные.

# H-Sofa

Design **Jérôme Gauthier** 2014

Divani  
Sofas



**9HS101**  
L77 P77 H74



**9HS201**  
L154 P77 H74



**9HS301**  
L154 P77 H74

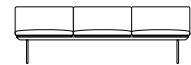
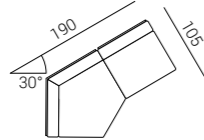

**9HS202**  
L231 P77 H74



**9HS302**  
L231 P77 H74

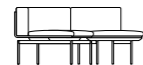

**9HS203**  
L190 P77 H74

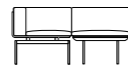

**9HS204**  
L154 P77 H74

Base in metallo  
Metal Base

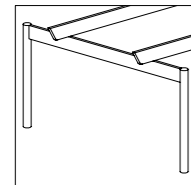

**Versione A**  
Basamento in metallo  
verniciato  
**Version A**  
Painted metal base

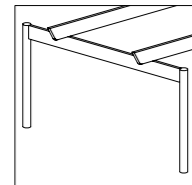

**Versione B**  
OPM1, OPM2, OPM3  
**Version B**  
OPM1, OPM2, OPM3

	Cherry Stained Oak	Wengé Stained Oak	Walnut Stained Oak	Natural Oak	Black Stained Oak	Cherry Milano Stained Oak	Tobacco Stained Oak	Grey taupe Stained Oak	Whitened Oak	Charcoal Stained Oak	Mahogany Stained Oak
<b>Code</b>	<b>OPR1</b>	<b>OPR2</b>	<b>OPR3</b>	<b>OPR4</b>	<b>OPR5</b>	<b>OPR6</b>	<b>OPR8</b>	<b>OPR9</b>	<b>OPR10</b>	<b>OPR11</b>	<b>OPR12</b>
Wooden Panels	●	●	●	●	●	●	●	●	●	●	●
	Oak	Painted in Ral Classic Colours									
Wooden Panels	●										
<b>Code</b>	Polished Chromed Metal	Matt Brushed Metal	Matt Dark Grey Brushed Metal	RAL 9016 Black	RAL 9017 White	Classic Bronze Painted Metal	RAL T019 Beige	RAL7044 Grey	RAL 9006 Aluminium	RAL 7006 Beige Grey	
<b>Code</b>	<b>OPM1</b>	<b>OPM2</b>	<b>OPM3</b>	<b>OPM6</b>	<b>OPM7</b>	<b>OPM9</b>					
Metal Base A	●	●	●	●	●	●	●	●	●	●	●
Metal Base B	●	●	●	●	●	●	●	●	●	●	●

Opzionali  
Optionals



**9SS802**  
L10 P10  
Schulte Evoline socket



**9SS805**  
ø14 H32  
Belux lamp

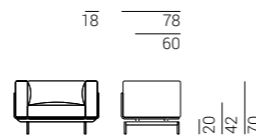

# H-Sofa

Design **Jérôme Gauthier** 2014

Struttura portante costituita da due tubolari di metallo cm 4 x 3. Piede in metallo diametro cm 2,5. Pannelli in multistrato impiallacciato rovere, spessore 2,1 cm. Cuscini in poliuretano espanso a quote differenziate, rivestito in dacron 100 gr: sedile T.40RC (kPa5); schienale PF30 (kPa4,3), PF30M (kPa 3,5), T.30HR (kPa 1,5); braccioli PF30 (kPa 4,3), T.30HR (kPa 1,5). Il rivestimento è sempre fisso.

Frame made of two metal tubes cm 4 x 3. Metal leg diameter cm 2.5. Multiply oak veneer panels, 2.1 cm thick. Cushions made of polyurethane foam in different densities, covered with dacron 100 gr: seat T.40RC (kPa5); back PF30 (kPa4,3), PF30M (kPa 3,5), T.30HR (kPa 1,5); armrests PF30 (kPa 4,3), T.30HR (kPa 1,5). Covers are always fixed.

Gestellkonstruktion mit 2 Querträgern 4-Kantrohr 4 x 3 cm, Metallfüsse mit Durchmesser 2,5 cm. Rücken- und Armlehnelemente aus Schichtholz Eiche furniert, Dicke 2,1 cm. Kissen aus Polyurethanschäumstoff in unterschiedlichen Dichten, mit Dacron 100 gr ummantelt: Sitzkissen T.40RC (kPa5); Rückenkissen PF30 (kPa4,3), PF30M (kPa 3,5), T.30HR (kPa 1,5); Armlehnkissen PF30 (kPa 4,3), T.30HR (kPa 1,5). L-Sofa ist immer fix bezogen.

Structure portante constituée de deux tubes en métal de 4 x 3 cm. Pied en métal diamètre 2,5 cm. Panneaux en multiplis plaqués chêne, épaisseur 2,1 cm. Coussins en mousse polyuréthane de différentes densités, revêtue de dacron 100 g: assise T.40RC (kPa5); dossier PF30 (kPa4,3), PF30M (kPa 3,5), T.30HR (kPa 1,5); accoudoirs PF30 (kPa 4,3), T.30HR (kPa 1,5). Le revêtement est toujours fixe.

De dragende structuur bestaat uit twee metalen buizen van 4 x 3 cm. Metalen poot diameter 2,5 cm. Multiplexpanelen eik gefineerd, dikte 2,1 cm. Kussens in koudschuim afgewerkt met dacron 100 g: zit T.40RC (kPa5); rug PF30 (kPa4,3), PF30M (kPa 3,5), T.30HR (kPa 1,5); armleuningen PF30 (kPa 4,3), T.30HR (kPa 1,5). De bekleding is altijd vast.

Несущий каркас образован двумя металлическими планками, размер в сечении 4 x 3см. Металлические ножки диаметром 2,5см. Панели из многослойной фанеры, отделанной шпоном дуба, толщина панели 2,1см. Наполнение подушек: вспененный полиуретан с участками различной плотности в чехле из дакрона весом 100гр. Подушка сиденья T.40RC (kPa5); подушка спинки schienale PF30 (kPa4,3), PF30M (kPa 3,5), T.30HR (kPa 1,5); подлокотники PF30 (kPa 4,3), T.30HR (kPa 1,5). Чехлы несъемные.

# Pivot

Design **Jérôme Gauthier** 2014

## Poltroncine Armchairs



**9PIV101**  
L55,5 P54 H80  
Swivel armchair



**9PIV102**  
L55,5 P54 H80  
Armchair with fixed base

## Tavoli Tables



**7PIV101**  
ø60 H43/61

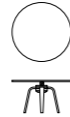

**7PIV102**  
ø78 H43/74

54 55,5 60 78  
47



Code	Cherry Stained Oak <b>OPR1</b>	Wengé Stained Oak <b>OPR2</b>	Walnut Stained Oak <b>OPR3</b>	Natural Oak <b>OPR4</b>	Black Stained Oak <b>OPR5</b>	Cherry Milano Stained Oak <b>OPR6</b>	Tobacco Stained Oak <b>OPR8</b>	Grey Taupe Stained Oak <b>OPR9</b>	Whitened Oak <b>OPR10</b>	Charcoal Stained Oak <b>OPR11</b>	Mahogany Stained Oak <b>OPR12</b>
Wooden Panels	●	●	●	●	●	●	●	●	●	●	●
Oak Painted in Ral Classic Colours	●										
Wooden Panels	●										

# Pivot

Design **Jérôme Gauthier** 2014

### Poltroncina:

Struttura in multistrato di faggio impiallacciato rovere.

Spessore della gamba 20 mm.

Imbottitura della seduta e dello schienale in poliuretano espanso densità 30 kg/m³, rivestito in dacron.

Il rivestimento è sempre fisso.

Lucidatura con finitura opaca a poro aperto. Antiscivolanti in plastica dura.

### Tavolini:

Base in multistrato di faggio impiallacciato rovere. Spessore della gamba 20 mm.

Piano in multistrato di pioppo impiallacciato rovere, spessore 18 mm.

Lucidatura con finitura opaca a poro aperto. Antiscivolanti in plastica dura.

### Armchair:

Frame in oak veneered beech plywood.

Leg 20 mm thick.

Seat and back upholstered with polyurethane foam with density 30 kg/m³, covered with dacron.

Fixed covers. Open-pore staining with matt finish. Glides in hard plastic.

### Tables:

Base in oak veneered beech plywood. Leg 20 mm thick.

Top in oak veneered poplar plywood, 18 mm thick.

Open-pore staining with matt finish. Glides in hard plastic.

### Sessel:

Das Gestell besteht aus Buchensperholz mit Eichenholz-Furnier.

Beinstärke 20 mm.

Sitz und Rücken gepolstert mit Polyurethanschaumstoff mit Dichte 30 Kg/m³, mit Dacron ummantelt.

Pivot ist immer festbezogen. Offenporiges Beizen in matter Ausführung.

Gleiter aus hartem Kunststoff.

### Tische:

Das Gestell besteht aus Buchensperholz mit Eichenholz-Furnier.

Plattenstärke 18 mm.

Offenporiges Beizen in matter Ausführung. Gleiter aus hartem Kunststoff.

### Fauteuil:

Structure en multiplis de hêtre plaqué chêne.

Épaisseur du pied 20 cm.

Rembourrage de l'assise et du dossier en mousse de polyuréthane densité 30 kg/m³, revêtue de dacron. Le revêtement est toujours fixe.

Teinture à pores ouverts finition mate. Patins en plastique dur.

### Tables basses:

Piètement en multiplis de hêtre plaqué chêne.

Épaisseur du pied 20 cm. Plateau en multiplis de peuplier plaqué chêne, épaisseur 18 mm.

Teinture à pores ouverts finition mate. Patins en plastique dur.

### Fauteuil:

Frame in beukenmultiplex eiken gefineerd.

Pootdikte 20 cm.

Vulling van zit en rug in koudschuim densiteit 30 kg/m³, bekleed met dacron.

De bekleding is altijd vast. Openporig mat gevernist. Glijders in harde kunststof.

### Tafeltjes:

Onderstel in beuken-multiplex eik gefineerd.

Pootdikte 20 cm. Blad in populierenmultiplex eiken gefineerd, dikte 18 mm.

Openporig mat gevernist. Glijders in harde kunststof.

### Полукресло:

Каркас из наборного массива бука, фанерованного шпоном дуба,

покрыт матовым лаком с сохранением видимой структуры дерева (т.н. открытые поры)

Толщина ножки 20см. Наполнение сидения и спинки из вспененного полиуретана плотностью 30кг/м³, обернутого в дакрон.

Обивка несъемная. Ножки снабжены противоскользящими накладками из твердой пластмассы.

### Столики:

Каркас из наборного массива бука, фанерованного шпоном дуба,

с сохранением видимой структуры дерева (т.н. открытые поры)

Толщина ножки 20см. Столешница толщиной 18см выполнена из наборного массива тополя, фанерованного шпоном дуба.

Ножки снабжены противоскользящими накладками из твердой пластмассы.

**graphic**  
Matteo Paoloni

**photo**  
IKB Studio

**print**  
Grafiche Boffi

all rights reserved © 2015

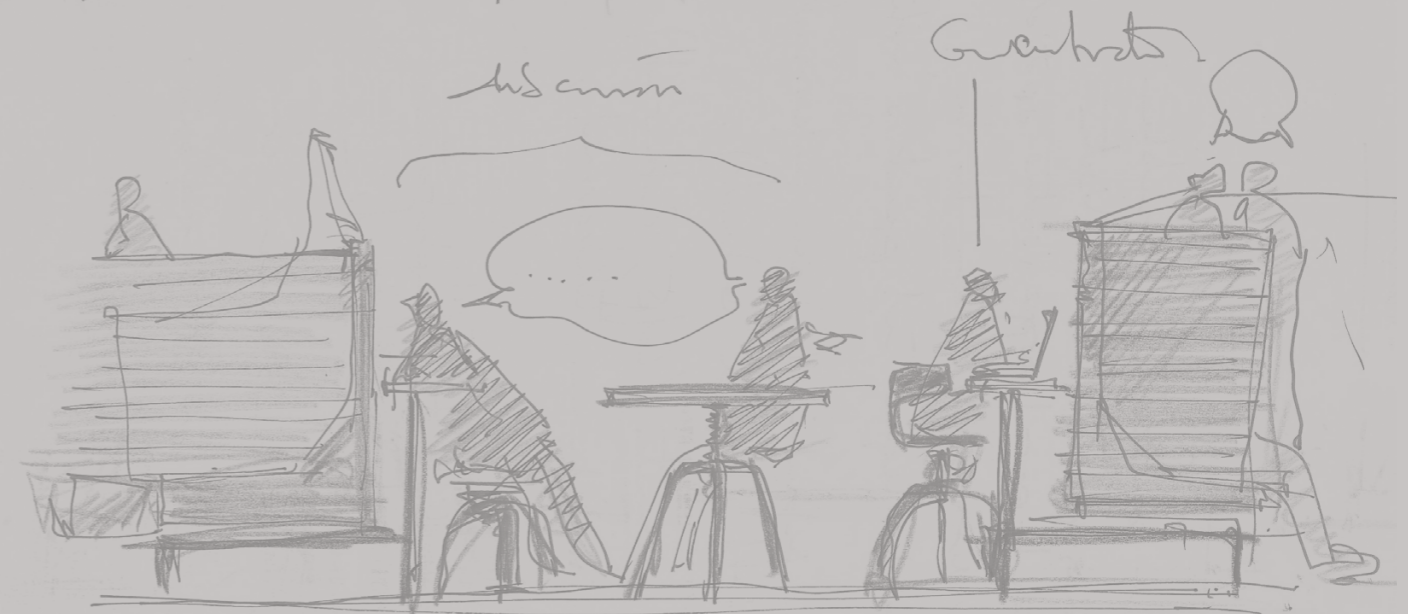
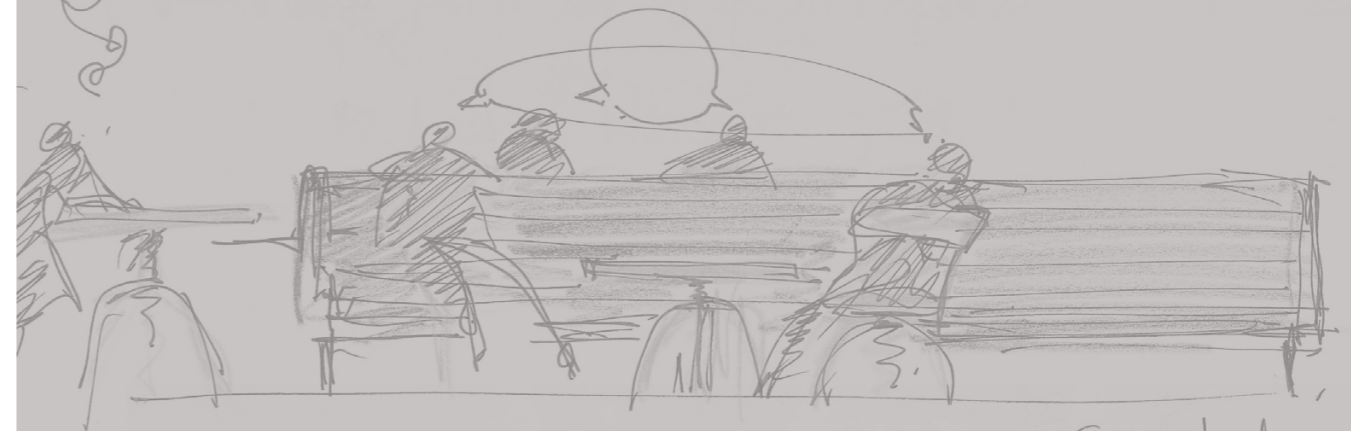

**marelli**

Giulio Marelli Italia SpA  
Via Indipendenza 159 20821 Meda (MB) ITALIA T +39 0362 342116  
info@giuliomarelli.com www.giuliomarelli.com

# marelli

**Giulio Marelli Italia SpA**  
Via Indipendenza 159  
20821 Meda (MB) ITALIA  
T +39 0362 342116  
[www.giuliomarelli.com](http://www.giuliomarelli.com)

